

CRD encoder as a subscriber in the PROFIBUS-DP

Accompanying data sheet: CRD 10534

User manual no.: CRD 10617 FE
Datum: 10.07.2012

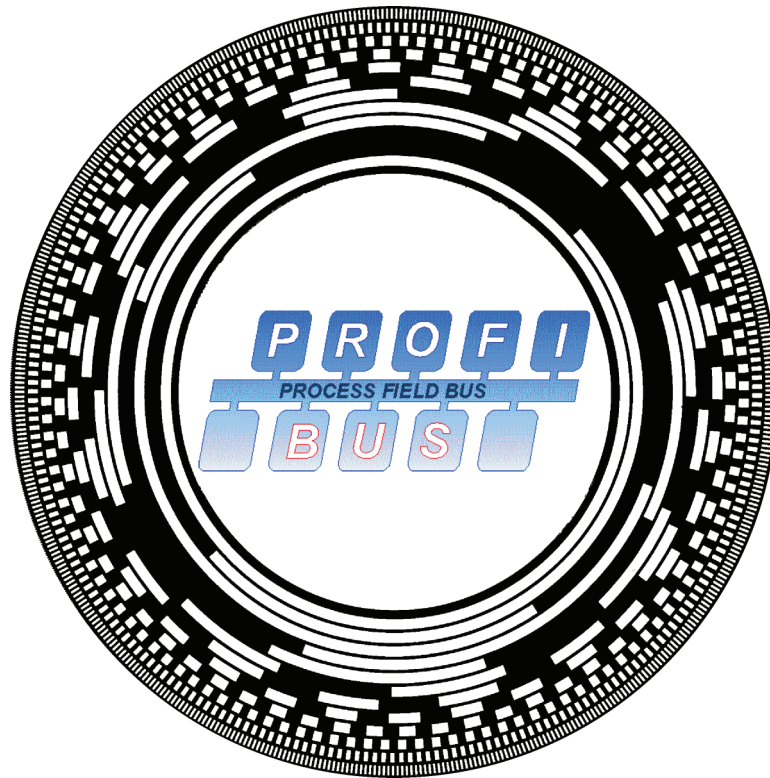

User manual

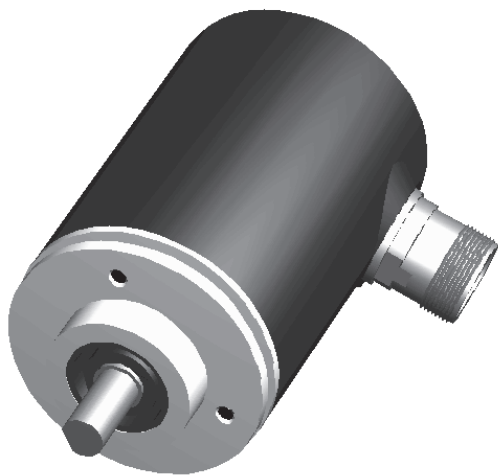

Certificate
Z00358



Certificate
Z00359

COPYRIGHT: The Operating Instructions CRD 10617
is owned by TWK-ELEKTRONIK GMBH and is
protected by copyright laws and international treaty provisions.

© 2012 by TWK-ELEKTRONIK GMBH
POB 10 50 63 ■ 40041 Düsseldorf ■ Germany
Tel. +49/211/63 20 67 ■ Fax +49/211/63 77 05
info@twk.de ■ www.twk.de

1. Safety instructions	5
1.1 Scope of validity.....	5
1.2 Documentation.....	5
1.3 Proper use	5
1.4 Commissioning	5
2 General	6
3. Installation instructions for PROFIBUS-DP - RS 485	7
3.1 Connection of encoder with RS plug	8
3.2 Connection of encoder with connecting cap	8
4. Configuration function (DDL_M_Chk_Cfg)	9
5. Data exchange function (DDL_M_Data_Exchange)	10
5.1 Actual position value	10
5.2 Set preset value	10
5.3 Example: Setting the preset value in 32 bit data format	11
6. Programming parameters for class 1/2 encoder (DDL_M_Set_Prm) /4/.....	12
6.1 Definition of the programming parameters	12
6.1.1 Operating mode	12
6.1.2 Measuring units per revolution (Octet 10-13).....	13
6.1.3 Total measuring range in units (Octet 14-17).....	13
6.2 Examples for parametration (User_Prm_Data)	14
7. Diagnosis messages (DDL_M_Slave_Diag).....	15
7.1 Standard diagnosis information (Octet 1-6):.....	15
7.2 Device-related diagnosis	15
7.2.1 Extended header byte (Octet 7):	15
7.2.2 Alarm messages (Octet 8):.....	16
7.2.3 Operating mode (Octet 9)	16
7.2.4 Encoder type (Octet 10).....	16
7.2.5 Single turn resolution (Octet 11-14)	16
7.2.6 Measuring range (Octet 15, 16).....	16
7.2.7 Additional alarm messages (Octet 17).....	16
7.2.8 Supported alarm messages (Octet 18,19).....	17
7.2.9 Warning messages (Octet 20,21)	17
7.2.10 Supported warnings (Octet 22,23).....	17
7.2.11 Profile version (Octet 24,25).....	17
7.2.12 Software version (Octet 26,27)	17
7.2.13 Operating time (Octet 28-31)	17
7.2.14 Offset value (Octet 32-35).....	17
7.2.15 Manufacturer offset value (Octet 36-39)	17

7.2.16 Single turn resolution (Octet 40-43)	18
7.2.17 Total measuring steps (Octet 44-47)	18
7.2.18 Serial number (Octet 48-57)	18
7.2.19 Reserved for future use (Octet 58,59)	18
7.2.20 Manufacturer-specific diagnosis (Octet 60-63)	18
7.2.21 Example of diagnosis message	19
8. Simatic Step7	20
8.1 Integration of the TWK profibus encoder	20
8.1.1 Installation of the GSD file	20
8.1.2 Installation of the TWK encoder symbol.....	20
8.1.3 Selection of the TWK encoder from the Step7 hardware catalogue	20
8.1.4 Configuration of the encoder.....	20
8.1.5 Allocation of profibus address	21
8.1.6 Setting the I/O addresses (S7 addresses).....	22
8.1.7 Parameterisation of the encoder	22
8.1.8 Setting the diagnosis address.....	23
8.2 Setting the subscriber address in the case of the plug-version encoder	23
8.3 Example programmes.....	24
8.3.1 The TWKDPCL1 project.....	24
8.3.2 The TWKDPCL2 project.....	25
8.3.3 Installation of the example programmes	25
8.3.4 Explanations regarding the example programmes	27
9. Scope of delivery.....	28
10. Literature	28
Appendix A: Encoder terms	28

1. Safety instructions

1.1 Scope of validity

This user manual applies exclusively to the following rotary encoders with PROFIsafe interface:

- CRDxx-xxxxRxxxxC2Z01
- CRDxx-xxxxRxxxxC2L01

1.2 Documentation

The following documents must be noted:

- The owner's system-specific operating instructions
- This user manual
- Data sheet number CRD 10534
- The pin assignment enclosed with the device
- Installation instruction TZY 10206 enclosed with the device

1.3 Proper use

TWK-ELEKTRONIK GmbH's rotary encoders and linear transducers are used to record rotary and linear positions, and make their measured values available as an electric output signal. As part of a system, they must be connected to the downstream electronics and must only be used for this purpose.

1.4 Commissioning

- The relevant device must only be set up and operated using this document and the documentation specified in point 1.2.
- Protect the device against mechanical damage during installation and operation.
- The device must only be commissioned and set up by a specialist electrician.
- Do not operate the device outside of the limit values which are specified in the data sheet.
- Check all electrical connections before commissioning the system.

2 General

The PROFIBUS is a field bus standard according to EN 50170. The technical and functional characteristics of the field bus system are defined in this standard. The protocol architecture is based on the OSI reference model, in accordance with the international ISO 7498 standard. Layer 1 (Physical Layer) defines the transmission physics, layer 2 (Data Link Layer) the bus access protocol, and layer 7 (Application Layer) the application functions. This document is based on the Profil description for encoders which can be obtained from the PNO /1/. The Profibus protocol chip SPC 3 from Siemens is used as the interface module between the encoder electronics and the bus system.

For PROFIBUS-DP, data exchange between SPS/PC and the decentralised periphery (e.g. encoder) is carried out in a predominantly cyclical manner. For parameterisation, diagnosis and alarm handling purposes, acyclical communication functions are also required for intelligent field devices. In this case, reference must be made to the DIN 19245 Part 1 and 3 or to the EN 50170 standards.

In the case of PROFIBUS-DP, communication in the data back-up layer (layer 2) is carried out via the SRD (Send and Request Data with Reply) and SDN (Send Data with no Acknowledge) functions.

Mono or multi-master systems may be implemented with PROFIBUS-DP. A maximum of 126 devices (master or slaves) may be connected to one bus. The definition of the system configuration contains the number of stations, the allocation of the station address to the I/O addresses, data consistency of the I/O data, format of the diagnosis messages and the bus parameters which are used.

The parameters of the PROFIBUS subscribers are described in a GSD file (device data sheet). The specifications are executed in accordance with DIN 19245 Part 3 /4/.

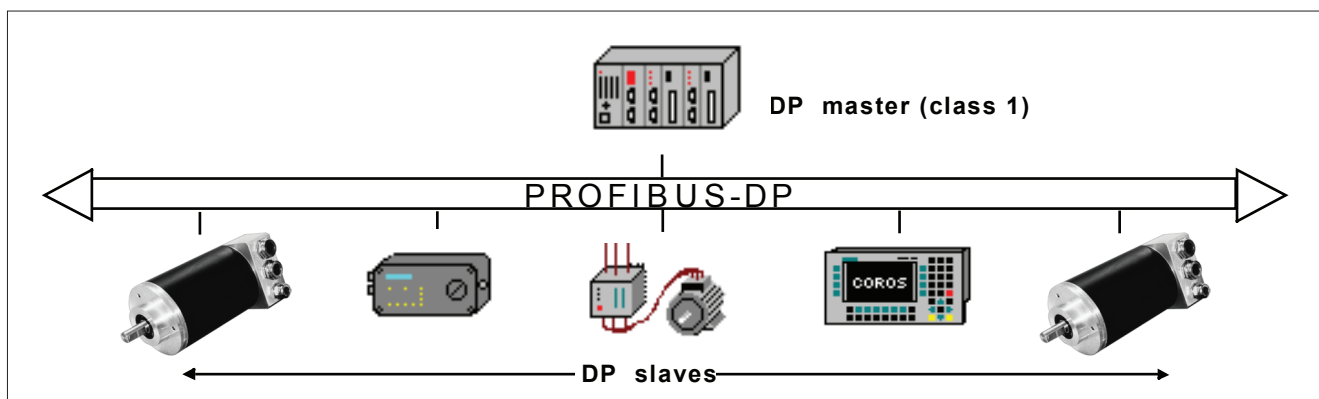

Differentiation of the services, and an exact knowledge of these, are especially important for understanding the PROFIBUS-DP philosophy. A distinction is made between the following in the manual:

- Check_Configuration: *Configuration of the encoder*
 Integration of the encoder into the network with various data formats, or as a programmable or non-programmable slave, is possible.
 (Example: F1: programmable (32 bit input/output data) multitour encoder)
- Data_Exchange: *Position data of the encoder*
 Cyclical enquiry regarding the encoder position. The position value is depicted as a 16 bit or 32 bit value depending on the configuration.
Setting the preset value
- Set_Parameter: *Programming parameters*
 Definition of the operating mode of the encoder and definition of the values for single turn resolution and total measuring range in units.
- Slave_Diagnosis: *Diagnosis of the slave subscriber (encoder)*

Installation instructions

3. Installation instructions for PROFIBUS-DP - RS 485

Basic characteristics of RS-485 transmission technology /2/:

- Network topology: Linear bus, terminating resistors for bus termination
Stub lines are only permissible in the case of baudrates < 1.5 MBit/s
- Lead: Sheathed, twisted pair cable
- Number of stations: 32 stations in each segment without repeaters
Can be extended up to 126 with repeaters.
- Plug-type connector: Variants implemented in the case of the CRD model series:
Connecting cap, Round plug RS 25, 12-pin
DESINA (LWL and Cu-version)
(pin assignment according to /1/)

Wiring and bus termination for PROFIBUS-DP /2/, (Note: 9-pin Sub-D plug)

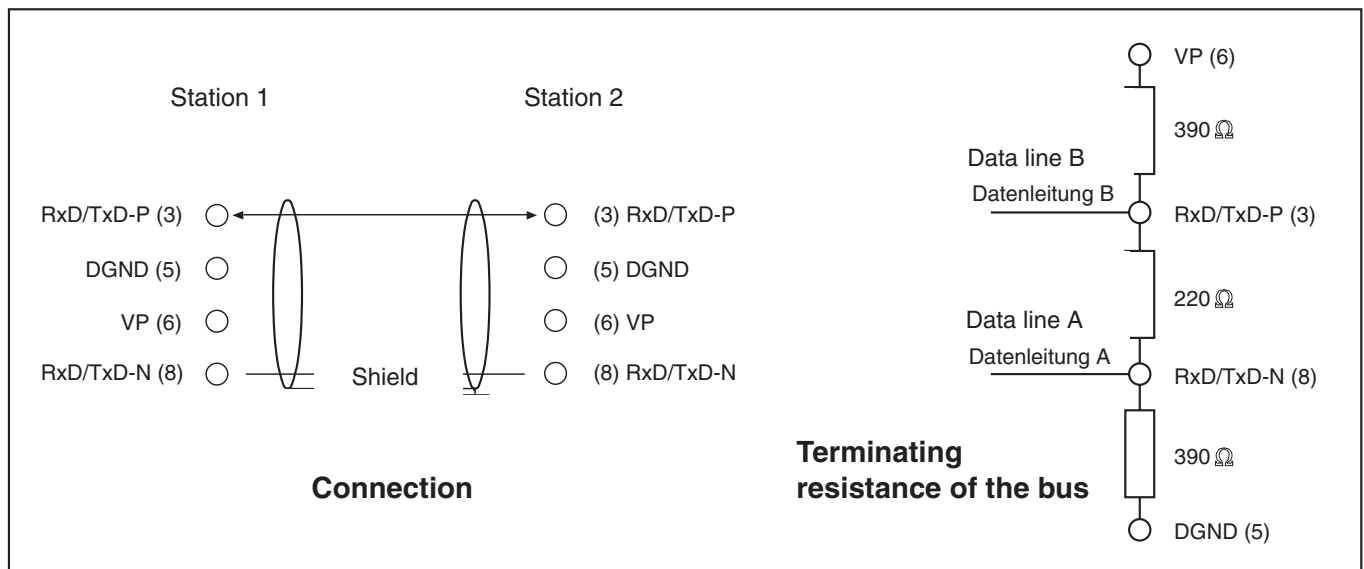

Transmission length depending on transmission speed for cable type A							
Baud rate (kBit/s)	9,6	19,2	93,75	187,5	500	1.500	12.000
Transmission length in (m)	1200	1200	1200	1000	400	200	100

Cable type A specifications:

Characteristic impedance:	135...165 Ohm
Capacitance per unit length coating:	< 30 pF/m
Loop resistance:	110 Ohm /km
Core diameter:	0.64 mm
Core cross-section:	> 0.34 mm ²

also see: Installation guideline for PROFIBUS -FMS/DP (PNO No. 2.111/2)
Implementation guide DIN 19245 Part 3 (PNO No. 2.001/2)

Installation instructions

3.1 Connection of encoder with RS plug

The-pin assignment for the 12-pin RS plug (Note: Numeration of the-pins in clockwise direction (view facing contact side of the bushing), encoder: Bushing) conforms to the profile definition for encoders /1/. The terminating resistors must be implemented in the counterplug or in the subsequent electronics. For this connection type attention should be paid to the length of the branch lines in the bus system and the total bus length.

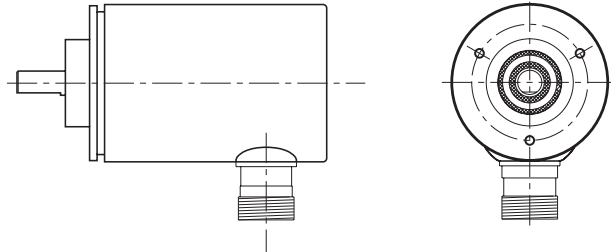

When delivered, each encoder with RS plug has the default address 123. Via the DP master, it is possible to change the address of a DP slave. The slave address which is to be newly assigned must lie within the range 1-126 (DDL_M_Set_Slave_Add).

3.2 Connection of encoder with connecting cap

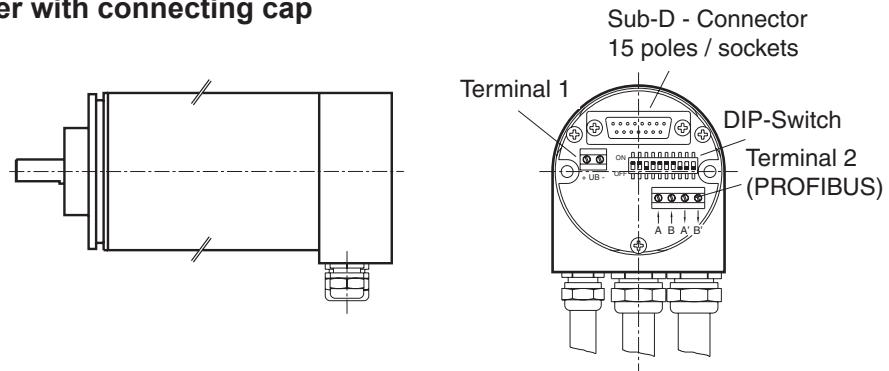

The connecting cap for triple connection technology is a T-coupler, which is installed in the PROFIBUS. It is equipped with three PG connections, which are subdivided as follows:

- PG 7: Voltage supply for the encoder (24 VDC +/-)
- PG 9: Bus in (Receive/transmit data A,B)
- PG 9: Bus out (Receive/transmit data A',B')

The encoder is connected via the 15-pin SUB-D plug. In the event of an error, the encoder can be replaced without time-consuming installation. The connecting cap is disconnected from the encoder by undoing 2 fastening screws (Note: O-ring seal)

Setting the station/subscriber address is carried out via the DIP switches in the connecting cap. The address range lies between 1 and 126 (Default address: 123). The address cannot be changed via the DDL_M_Set_Slave_Add service. (Note: GSD file in accordance with encoder version).

Setting the terminating resistors is carried out via the 10-fold DIP switch (9,10) in the connecting cap, which may be activated as lead termination as required.

DIP switch – address setting/terminating resistors

Switch	1	2	3	4	5	6	7	8	9	10	
ON = 1	2 ⁰ 2 ¹ ...						2 ⁷		n.c.	Termination resistors on	
OFF = 0	Address 1 - 126 can be set (123: Default address)									Termination resistors off	

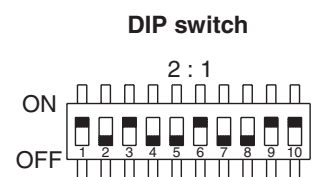

Installation

Status LED (connecting cap)

	VS	SRD	C	Err
Incorrect configuration	x	x		x
Impermissible parameter	x		x	x
Code error (see diagnosis bytes 62 - 63)	x			x
Class 1 Gerätekonfiguration i.O.	x	x		
Class 2 Gerätekonfiguration i.O.	x	x	x	

VS - power supply, Err - error, C - class, SRD - data traffic

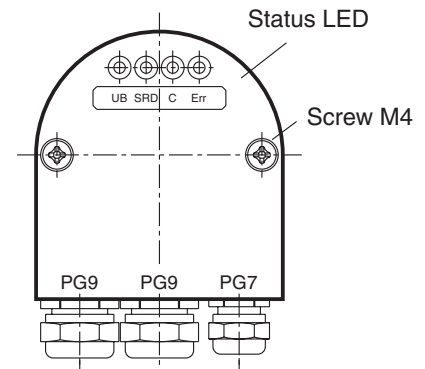

Configuration

4. Configuration function (DDL_M_Cfg)

The absolute encoders with PROFIBUS-DP are classified as follows:

Encoder with Class 1 functionality

Class 1 devices are characterised by the fact that only the position value (16 bit or 32 bit) of the encoder is transmitted via the bus. No parameterisation of encoder parameters is carried out. In this case, a distinction is made between the D0 and D1 configurations. The D0 configuration contains the data format: 1 word input data, consistency and D1 contains 2 word input data, consistency.

Encoder with Class 2 functionality

Class 2 devices are characterised by the fact that they can be parameterised via the bus. In this case, a distinction is made between the F0 and F1 configurations. The F0 configuration has the data format 1 word input data, 1 word output data, consistency and F1 contains 2 word input data, 2 word output data, consistency .

Possible configurations of the encoder:

Configuration function (DDL_M_Cfg)				
Selection	Class	Data	Identifier byte	Assignment Octet-No. and MSB/LSB
Class 2 32 Bit In/ Out	2	32 Bit In/ Output data	F1	Octet 1/Bit 7: MSB Octet 4/Bit 0: LSB
Class 2 16 Bit In/ Out	2	16 Bit In/ Output data	F0	Octet 1/Bit 7: MSB Octet 2/Bit 0: LSB
Class 1 32 Bit In	1	32 Bit Input data	D1	Octet 1/Bit 7: MSB Octet 4/Bit 0: LSB
Class 1 16 Bit In	1	16 Bit Input data	D0	Octet 1/Bit 7: MSB Octet 2/Bit 0: LSB

5. Data exchange function (DDLML_Data_Exchange)

Input data are data which are transmitted from the peripheral devices to the master or into the bus. The control of the preset value (see below) is listed as an example of output data at this point.

5.1 Actual position value

The actual position value is output in 16 or 32 bit data format (input data), Please refer to the configuration of the encoder in the previous chapter.

Actual position value (DDLML_Data_Exchange) 16 bit data format

Input-Data		
Octet	1	2
Bit	(MSB) 15 - 8	7 - 0 (LSB)
Data	$2^{15} - 2^8$	$2^7 - 2^0$
	position value	

Actual position value (DDLML_Data_Exchange) 32 bit data format

Input-Data				
Octet	1	2	3	4
Bit	(MSB) 31 - 24	23 - 16	15 - 8	7 - 0 (LSB)
Data	$2^{31} - 2^{24}$	$2^{23} - 2^{16}$	$2^{15} - 2^8$	$2^7 - 2^0$
	position value			

5.2 Set preset value

The set preset value function should only be executed when the encoder shaft is stationary!

In order to compare machine position values and the absolute position of the encoder, setting the preset value is unavoidable in certain cases. The preset value is the position value which is displayed in the reference point. The possibility of setting the preset value is available in the case of the TWK encoder with class 2 functionality.

The user must note the fact that the preset value must lie within the total measuring range in units. In particular, this must be taken into consideration when changing the total measuring range in units.

The preset value (binary code) is transmitted in data exchange mode by setting bit 31 (32 bit data format) or bit 15 (16 bit data format).

The following explanations refer to the 32 bit data format.

Setting the preset value in 32 data format

Output-Data					
Octet	1		2	3	4
Bit	31	(MSB)30 - 24	23 - 16	15 - 8	7 - 0 (LSB)
Data	1/0	$2^{30} - 2^{24}$	$2^{23} - 2^{16}$	$2^{15} - 2^8$	$2^7 - 2^0$
	Preset Control	reference value			

5.3 Example: Setting the preset value in 32 bit data format

Output-Data					
Octet	1		2	3	4
Bit	31	30 - 0			
Data	1	00.0000.0000.0000.0000.0000.1000			
	Preset Control	reference value: 8			

Following the receipt of this message, an offset value (from the current actual position value and preset value) is calculated by the encoder. If the output position value is equal to the preset value, bit 31 can be reset by the master, as the preset mode is terminated. The timing diagrams are specified in a separate TY sheet.

Return to normal operation mode, 32 bit data format

Output-Data					
Octet	1		2	3	4
Bit	31	30 - 0			
Data	0	00.0000.0000.0000.0000.0000.1000			
	Preset Control	position value: 8			

After bit 31 = 0 has been reset, the encoder operates in normal operating mode. The offset value is stored in the diagnosis data and can be read in the event of a power failure and restarting (Also see Diagnosis messages in [Chapter 7](#)).

Programming parameters

Definition of the operating parameters:

- Code sequence: The code sequence defines the direction of rotation in which the position value corresponds to increasing values (viewed in the direction of the shaft).
 - CW - clockwise
 - CCW - counter clockwise

- Class 2: This operating parameter serves to distinguish between encoders with class 1 or class 2 functions.
 - Class 1 - Code sequence, release of the class 2 functions
 - Class 2 - Contains class 1 functions Scaling function control (see below)

- Diagnosis: routine: The diagnosis routine enables the extensive examination of all encoder components to ensure perfect functional capability. The routine is run through each time the device is switched on. If faults are determined by the diagnosis routine, these are displayed with the alarm bit. This function is not currently supported.

- Scaling function: The scaling function control releases the parameterisation of the single turn resolution and the total measuring range in units. This function is only effective when changing the single turn resolution and total measuring range in units parameters. Following the execution of scaling function control, the position value is recalculated and output.

6.1.2 Measuring units per revolution (Octet 10-13)

Operating parameter	resolution			
Octet	10	11	12	13
Bit	(MSB) 31-24	23-16	15-8	7-0 (LSB)
Data	$2^{31}-2^{24}$	$2^{23}-2^{16}$	$2^{15}-2^8$	2^7-2^0

6.1.3 Total measuring range in units (Octet 14-17)

Operating parameter	total measuring steps			
Octet	14	15	16	17
Bit	(MSB) 31-24	23-16	15-8	7-0 (LSB)
Data	$2^{31}-2^{24}$	$2^{23}-2^{16}$	$2^{15}-2^8$	2^7-2^0

Note: It must be noted that the calculation of the number of revolutions is carried out in 2^n powers internally within the encoder. Regardless of this requirement, the user may programme the desired total measuring range in units and the desired single turn resolution in accordance with the application. During calculation, the encoder accesses the next highest 2^n power if required. In this case, the values are designated as the actual single turn resolution or as the actual total measuring range in units, and are displayed as the output value.

Example:

desired total measuring range in units	:	20480
desired single turn resolution	:	4096
 desired number of revolutions	 :	 5
 internal encoder calculation		
actual total measuring range in units	:	32768
actual single turn resolution	:	4096
 calculated number of revolutions	 :	 8

Programming parameters

(Note: The above mentioned note must be taken into consideration in the event of irreversible operation. In the example which is described, the position 0 is only achieved after 32767 steps and not, as desired, after 20479 steps.)

6.2 Examples for parametrization (User_Prm_Data)

Class 1 encoder (9 parameter bytes, inclusive 7 bytes bus specific data)*

Class 1 encoder				
	bus specific data		operating status	remarks
octet	01 - 07	08	09	
data		00	00	Bit 0=0 code sense: CW Bit 1=0 class1
data		00	01	Bit 0=1 codesense: CCW Bit 1=0 class1

Class 2 encoder (29 parameter data, inclusive 7 bytes bus specific data)*

Class 2 encoder						
	bus specific data		operating status	steps/turn	total steps	
octet	01 - 07	08	09	10 - 13	14 - 17	18 - 29
data		00	0A	Bit 0=0 code sense: CW Bit 1=1 class 2 Bit 2=0 no diagnosis Bit 3=1 scaling on	1.000	1.000.000
data		00	0B	Bit 0=1 code sense: CCW Bit 1=1 class 2 Bit 2=0 no diagnosis Bit 3=1 scaling on	100	10.000

* example contains only DP-slave specific parameter data (see DIN 19245-3)

Diagnosis messages

7. Diagnosis messages (DDLm_Slave_Diag)

Overview of diagnosis information

Diagnosis octet number	diagnosis function	class
1 - 6	standard diagnosis information	1, 2
	device specific diagnosis	
7	extended headerbyte	1, 2
8	alarm messages	1, 2
9	operating parameters encoder	1, 2
10	encoder type	1, 2
11(MSB) - 14 (LSB)	resolution	1, 2
15 - 16	measuring range	1, 2
End of diagnosis data for class 1 encoder!		
17	additional alarm messages	2
18 - 19	supported alarm messages	2
20 - 21	warning messages	2
22 - 23	supported warnings	2
24 - 25	profil version	2
26 - 27	software version	2
28 - 31	operating time	2
32 - 35	offset	2
36 - 39	manufacturer offsetwert	2
40(MSB) - 43(LSB)	resolution	2
44(MSB) - 47(LSB)	total measuring steps	2
48 - 57	serial number	2
58 - 59	reserved	2
60 - 63	manufacturer specific diagnosis	2

Explanations regarding the diagnosis information:

7.1 Standard diagnosis information (Octet 1-6):

For detailed description, see DIN 19245-3 /4/

(Note: Octet 5,6: Manufacturer identification: 1962H)

This manufacturer identification number is stored in the PNO, and identifies the subscriber as a TWK encoder.

7.2 Device-related diagnosis

In the range from Octet 7 up to max. 244 (according to standard /4/), the DP slave may store its specific diagnosis.

7.2.1 Extended header byte (Octet 7):

In the header diagnosis (Octet 7), the length of the extended diagnosis bytes, including the header, is specified.

(Class 1 encoder: 0AH = 10 d

-> 6 (Standard diagnosis) + 1(Octet 7)+ 9 (Octet 8-16) = 16 diagnosis bytes,

Class 2 encoder: 39H = 57d

-> 6 (Standard diagnosis) + 1(Octet 7)+ 56 (Octet 8-63) = 63 diagnosis bytes)

Parameter	extended headerbyte		
Diagnosis octet	7		
Bit	0-5	6	7
Data	xxhex	0	0
Definition	length inclusive header	display of device diagnosis	

Diagnosis messages

7.2.2 Alarm messages (Octet 8):

Output of the current alarm status. TWK currently supports memory errors only.

Parameter	alarm messages					
Diagnosis octet	8					
Bit	0	1	2	3	4	5-7
Data	0=no /1=yes	0=no /1=yes	0=no /1=yes	0=no /1=yes	0=no /1=yes	
Definition	Position error	Supply voltage error	Current to high	Commissioning diagnosis	Memory error	currently not assigned
Remarks	not supported	not supported	not supported	not supported	supported	

7.2.3 Operating mode (Octet 9)

Current encoder status. This byte is described via the parameterisation of the master, and is read by the diagnosis string.

Parameter	operating mode				
Diagnosis octet	9				
Bit	0	1	2	3	4-7
Data	0=CW /1=CCW	0=no /1=yes	0=no /1=yes	0=no /1=yes	
Definition	code sense	class2 functionality	diagnosis function	scaling function	currently not assigned
Remarks			not supported		

7.2.4 Encoder type (Octet 10)

The encoder type is set to multitour absolute. The code is stored in hexadecimal form (00-FFH)

Parameter	encoder type
Diagnosis octet	10
Bit	0-7
Data	01hex
Definition	Multiturn absolut

7.2.5 Single turn resolution (Octet 11-14)

The maximum possible selection of measuring units per revolution, specified via the single turn resolution of the encoder shaft. The value is stored in the binary code.

Parameter	resolution			
Diagnosis octet	11	12	13	14
Bit	(MSB) 31-24	23-16	15-8	7-0 (LSB)
Data	$2^{31}-2^{24}$	$2^{23}-2^{16}$	$2^{15}-2^8$	2^7-2^0

7.2.6 Measuring range (Octet 15, 16)

The maximum possible number of revolutions, specified via the single turn resolution of the multitour section. Depiction in hexadecimal form, e.g. 4096 revolutions = 1000H.

Parameter	measuring range	
Diagnosis octet	15	16
Bit	(MSB) 15-8	7-0 (LSB)
Data	$2^{15}-2^8$	2^7-2^0

End of diagnosis data for class 1 encoder !

7.2.7 Additional alarm messages (Octet 17)

Not currently assigned.

Diagnosis messages

7.2.8 Supported alarm messages (Octet 18,19)

The error entitled memory error is currently supported (10H).

Parameter	supported alarm messages					
Diagnosis octet	18 - 19					
Bit	0	1	2	3	4	5-15
Data	0=no /1=yes	0=no /1=yes	0=no /1=yes	0=no /1=yes	0=no /1=yes	
Definition	Position error	Supply voltage error	Current to high	Commissioning diagnosis	Memory error	currently not assigned
Remarks	not supported	not supported	not supported	not supported	supported	

7.2.9 Warning messages (Octet 20,21)

This function is not currently supported.

7.2.10 Supported warnings (Octet 22,23)

This function is not currently supported.

7.2.11 Profile version (Octet 24,25)

Profile version: e.g. 01.00

Parameter	profil version	
Diagnosis octet	24	25
Bit	15-8	7-0
Data	$2^{15}-2^8$	2^7-2^0
Definition	revision number	index

7.2.12 Software version (Octet 26,27)

Software version: e.g. 01.00

Parameter	software version	
Diagnosis octet	26	27
Bit	15-8	7-0
Data	$2^{15}-2^8$	2^7-2^0
Definition	revision number	index

7.2.13 Operating time (Octet 28-31)

This function is not currently supported. The operating time default is set as $FFFF\ FFFF_{hex}$ in accordance with the encoder profile.

7.2.14 Offset value (Octet 32-35)

The offset is the shift in the zero point on setting the reference point, with reference to the output (according to the calculation).

Parameter	offset value			
Diagnosis octet	32	33	34	35
Bit	(MSB) 31-24	23-16	15-8	7-0 (LSB)
Data	$2^{31}-2^{24}$	$2^{23}-2^{16}$	$2^{15}-2^8$	2^7-2^0

7.2.15 Manufacturer offset value (Octet 36-39)

The manufacturer offset is the shift in the zero point of the encoder with regard to its physical zero point. The manufacturer offset value is not currently supported (Assignment: 00 00 00 00H).

Diagnosis messages

7.2.16 Single turn resolution (Octet 40-43)

In this case, the single turn resolution set in the parameter programme is reflected.

Parameter	single turn resolution			
Diagnosis Octet	40	41	42	43
Bit	(MSB) 31-24	23-16	15-8	7-0 (LSB)
Data	$2^{31}-2^{24}$	$2^{23}-2^{16}$	$2^{15}-2^8$	2^7-2^0

7.2.17 Total measuring steps (Octet 44-47)

In this case, the total measuring units per revolution set in the parameter programme is reflected.

Parameter	total measuring steps			
Diagnosis Octet	44	45	46	47
Bit	(MSB) 31-24	23-16	15-8	7-0 (LSB)
Data	$2^{31}-2^{24}$	$2^{23}-2^{16}$	$2^{15}-2^8$	2^7-2^0

7.2.18 Serial number (Octet 48-57)

This parameter is not currently supported.

Parameter	serial number									
Diagnosis Octet	48	49	50	51	52	53	54	55	56	57
Data	2A	2A	2A	2A	2A	2A	2A	2A	2A	2A

7.2.19 Reserved for future use (Octet 58,59)

7.2.20 Manufacturer-specific diagnosis (Octet 60-63)

Octet Number	Bit	Definiton	Function	Remarks
60	0 - 7	reserved		
61	0 - 7	reservied		
62	0	ErrEE	EEPROM error	reset encoder
	1	ErrMSA	MSA error	reset encoder
	2	ErrXRAM	error external RAM	reset encoder
	3	ErrExp	error connectiong cap	reset encoder
	4	IniFlg	initialising EEPROM	
	5 - 7	reserved		
63	0	ErrCRCO	CRC0 error	re-program and restart encoder
	1	ErrCRC1	CRC1 error	re-program and restart encoder
	2	ErrPar	parameter value error	re-program encoder
	3	ErrSkal	scaling error	
	4	ErrMem	ROM-Code error	reset encoder
	5	ErrInt	internal controler error	reset encoder
	6	ErrPre	referenz value error	reference value must be in the range of: 0 - total measuring steps - 1
	7	ErrStat	unknown command	

Diagnosis messages

* If a faulty preset value is input, control bit 31 must be set to zero before inputting the correct preset value in order to eradicate the error. The preset value can subsequently be reset after setting control bit 31 to 1. After resetting bit 31 to the value zero, the position value may then be output.

7.2.21 Example of diagnosis message

Octet	1	2	3	4	5	6	7	8	9	10	11	12	13	14	15	16
01-16	00	0C	00	02	19	62	39	00	0A	01	00	00	10	00	10	00
17-32	00	00	10	00	00	00	00	01	00	01	70	FF	FF	FF	FF	00
33-48	00	0A	D4	00	00	00	00	00	00	10	00	01	00	00	00	2A
48-63	2A	2A	2A	2A	2A	2A	2A	2A	2A	00	00	00	00	00	00	

Explanation: Octet:	Parameter	Data	Remarks	
1 - 6	Standard diagnosis information	01	00 hex	
		02	0C hex	Response monitoring activated, bit 2 set to 1
		03	00 hex	
		04	02 hex	Parameterisation via master with address 02
		05 - 06	1962 hex	Ident_Number CRD
7	Extended header byte	39 hex	63 diagnosis bytes	
8	Alarm messages	00 hex	No alarms are present	
9	Operating mode	0A hex	CW, class 2, diagnosis: no, scaling yes	
10	Encoder type	01 hex	Multitour, absolute	
11 - 14	Single turn resolution	1000 hex	4096 S/U	
15 - 16	Measuring range	1000 hex	16.777.216 Total measuring range	
17	Additional alarm messages	00 hex	No alarms are present	
18-19	Supported alarm messages	0010 hex	Memory error is supported	
20-21	Warning messages	0000 hex	wird nicht unterstützt	
22-23	Supported alarm messages	0000 hex	wird nicht unterstützt	
24-25	Profile version	01.00	Hardware version: 1.00	
26-27	Software version	01.70	Software version: 1.70	
28-31	Operating time	FFFFFFFF hex		
32-35	Offset value	0000AD4 hex	Offsetwert	
36-39	Manufacturer offset value	00000000 hex	Is not currently supported	
40-43	Single turn resolution	00001000 hex	4096 S/U	
44-47	Total measuring units per revolution	01000000 hex	16.777.216 Schritte	
48-57	Serial number	2A2A2A2A2A2A2A2A2A hex		
58-59	Reserved for future use	0000 hex		
60-63	Manufacturer-specific diagnosis	00000000 hex	No errors are present	

8. Simatic Step7

This Chapter explains the procedure for integrating the TWK encoder into the profibus of Siemens S7 control system, and the set up and the utilisation of the example programmes for Step7. The basis of the documentation is Step 7 Version 5.1.

8.1 Integration of the TWK profibus encoder

Prerequisites: You have configured your hardware in accordance with the structure of your control system, and have installed a profibus subnetwork.

8.1.1 Installation of the GSD file

- The GSD-file and the encoder symbols (bitmaps) are available under www.twk.de menu Documentation
- Close all projects in the hardware configuration.
- In the hardware configuration, select **Install new GSD** under **Options**.
- Select the GSD file which corresponds to your encoder:
 - Version with connecting cap: TWKZ1962.GSD
 - Version with plug connection: TWKL1962.GSD
- Update the Step7 hardware catalogue via **Options, Update Catalog**.

8.1.2 Installation of the TWK encoder symbol

Via the installation of the TWK encoder symbol, your encoder is not depicted as an unknown subscriber in the hardware configuration, but assumes the appearance of your encoder. This is not, however, of significance as regards the function of the encoder.

In order to install the symbol (bitmap), copy the two files: CRD_Z_an.BMP and CRD_L_an.BMP into the C:\Siemens\Step7\S7Data\NSBMP\ directory (if C: is your S7 drive). The symbols first appear after restarting the Simatic Manager.

8.1.3 Selection of the TWK encoder from the Step7 hardware catalogue

- After opening the hardware catalogue, you will find, under **Profibus-DP, Additional Field Devices, General**, the TWK Profibus encoder "Encoder CRD plug" (encoder in plug version) or "Encoder CRD cap" (encoder with connecting cap).
- Now open your project, mark the bus and integrate the encoder into the bus by double-clicking onto the corresponding line in the hardware catalogue (Encoder CRD plug or Encoder CRD cap).

8.1.4 Configuration of the encoder

After the appropriate encoder type has been selected in the (hardware) Catalog, the following window appears for the selection of encoder functionality and single turn resolution.

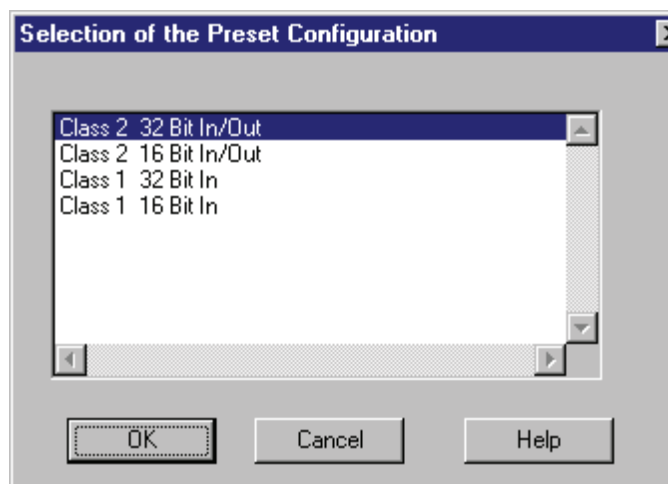

In this case, select class 1 or class 2 functionality and 16 or 32 bit single turn resolution in accordance with your requirements. (See [Chapter 4](#))

Simatic Step7

8.1.5 Allocation of profibus address

If you have selected your nominal configuration, the following window, in which you must specify the profibus address set in the encoder, appears. For the example programmes, please select address 123 for the first and address 122 for the second encoder here.

Note: The profibus address of the encoder is set, in the case of the cap version, via dip switches (See [Chapter 3.2](#)) and, in the case of the plug version, via software (See [Chapter 8.2](#)).

In addition, select your planned Profibus in the Subnet, and quit the window with OK.

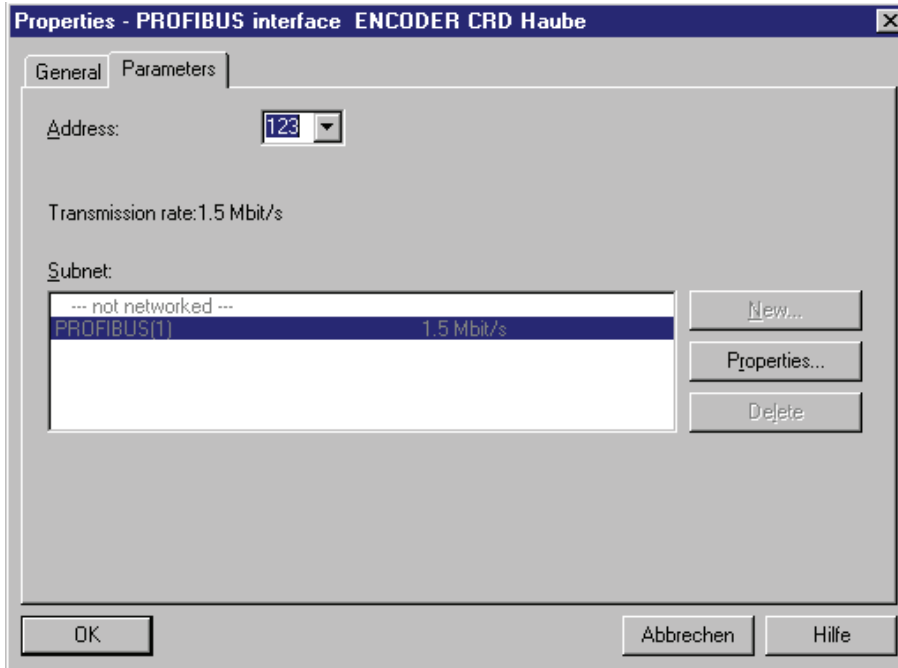

The encoder subsequently appears as a subscriber in your profibus. Depending on the configuration and address, this may appear as follows:

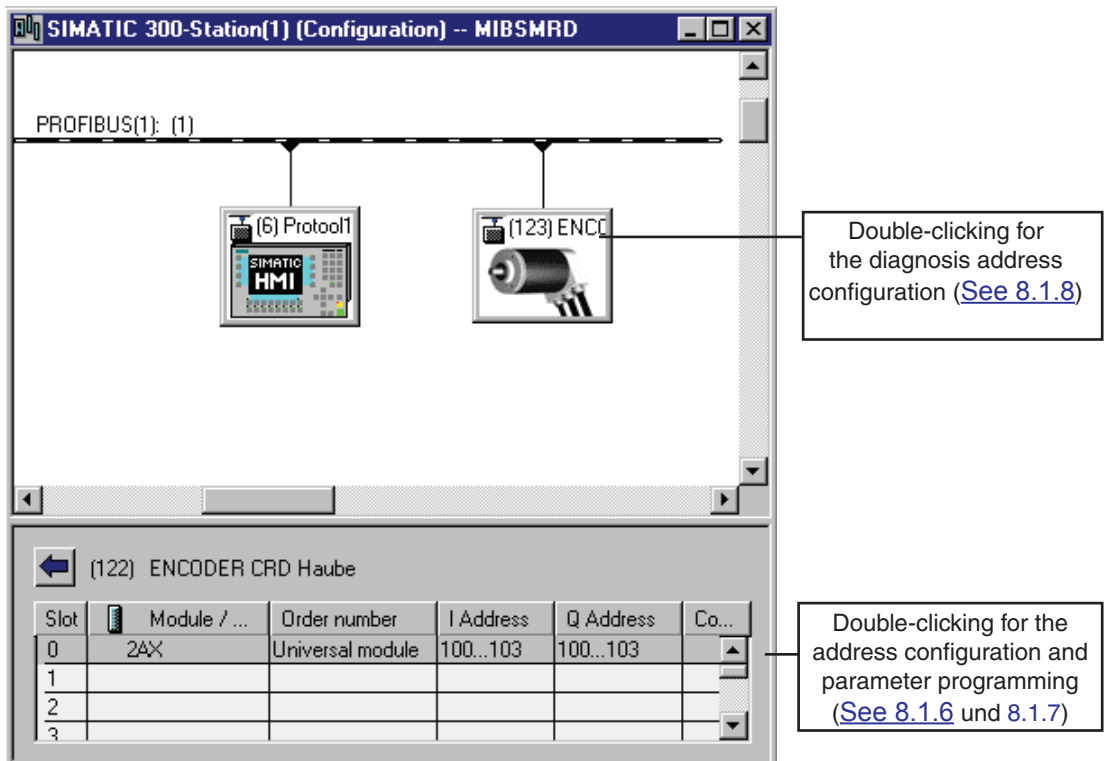

The value for Module / DP-ID results from the configuration which is selected. The values for I/O address are default values which may vary depending on the control system.

Simatic Step7

8.1.6 Setting the I/O addresses (S7 addresses)

Double-clicking onto the "Slot 0" line opens the **Properties - DP slave** window with the **Address / ID** and **Parameter Assignment** registers. In the Address / ID registers, under output (in the case of class 2 encoder only) and input, the addresses under which the encoder is to be addressed in S7 must be allocated. The other entries in this register should not be changed. The following Figure depicts an example of this register for a class 2 encoder with 32 bit single turn resolution.

For the example programme, please input address 100 for outputs and inputs.

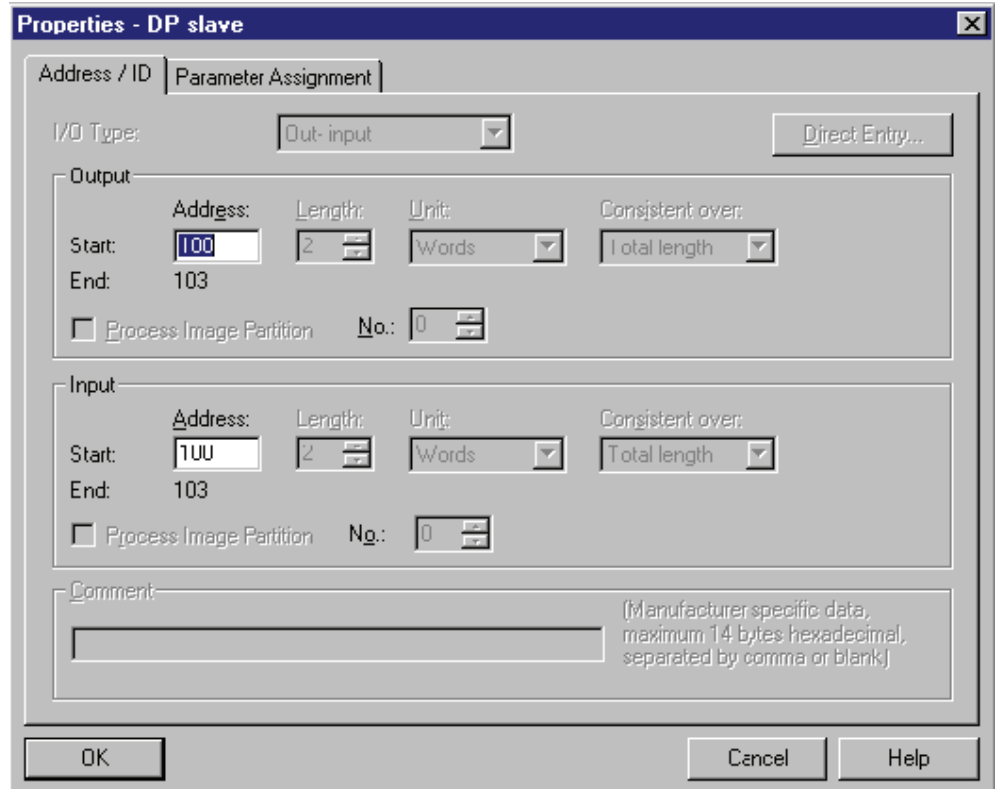

8.1.7 Parameterisation of the encoder

Via the **Parameter Assignment** register, the following window, in which the characteristics of the encoder can be defined, is accessed. The parameters of a class 2 slave are shown. In the case of a class 1 slave, only the code sequence parameter can be set here.

(See [Chapter 6](#))

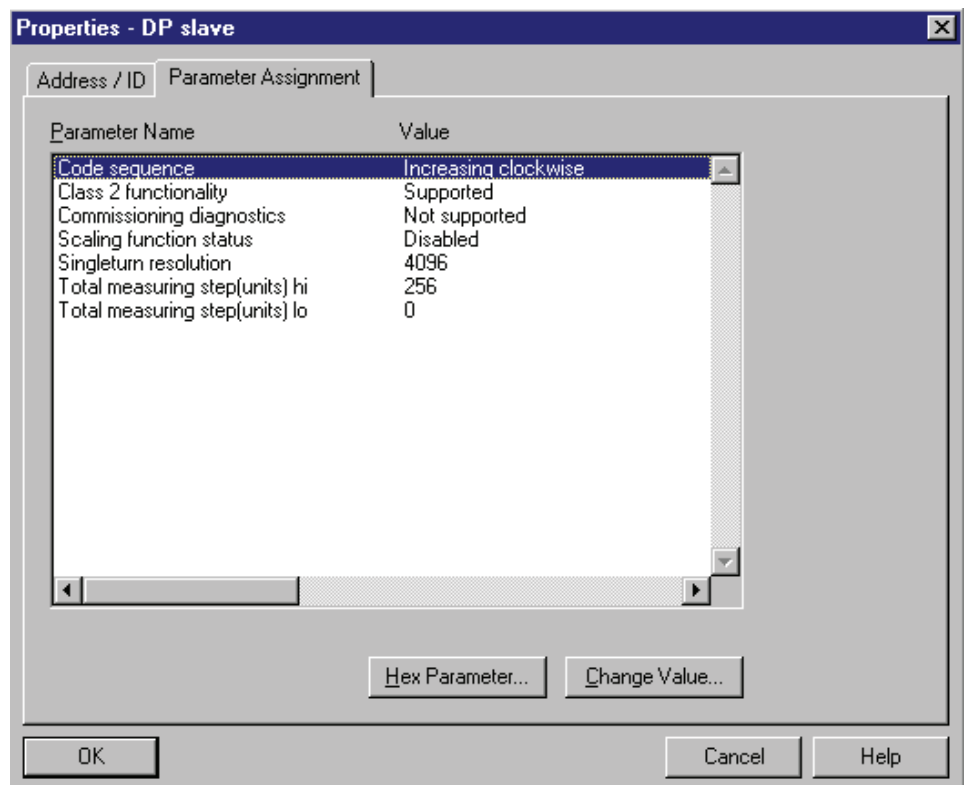

8.1.8 Setting the diagnosis address

Setting the diagnosis address is only required if the special profibus diagnosis functions are used within the S7 programme.

So that the diagnosis range of the encoder can be accessed within the S7 programme, a special S7 diagnosis address must be allocated to this. This address may lie within the entire peripheral range of the control system. It does not, therefore, occupy any input/output addresses.

By double-clicking onto the **encoder symbol**, the **Properties - DP slave** window appears with the **General** register. For the example programme please specify diagnosis address 200 for the first encoder and 202 for the second encoder.

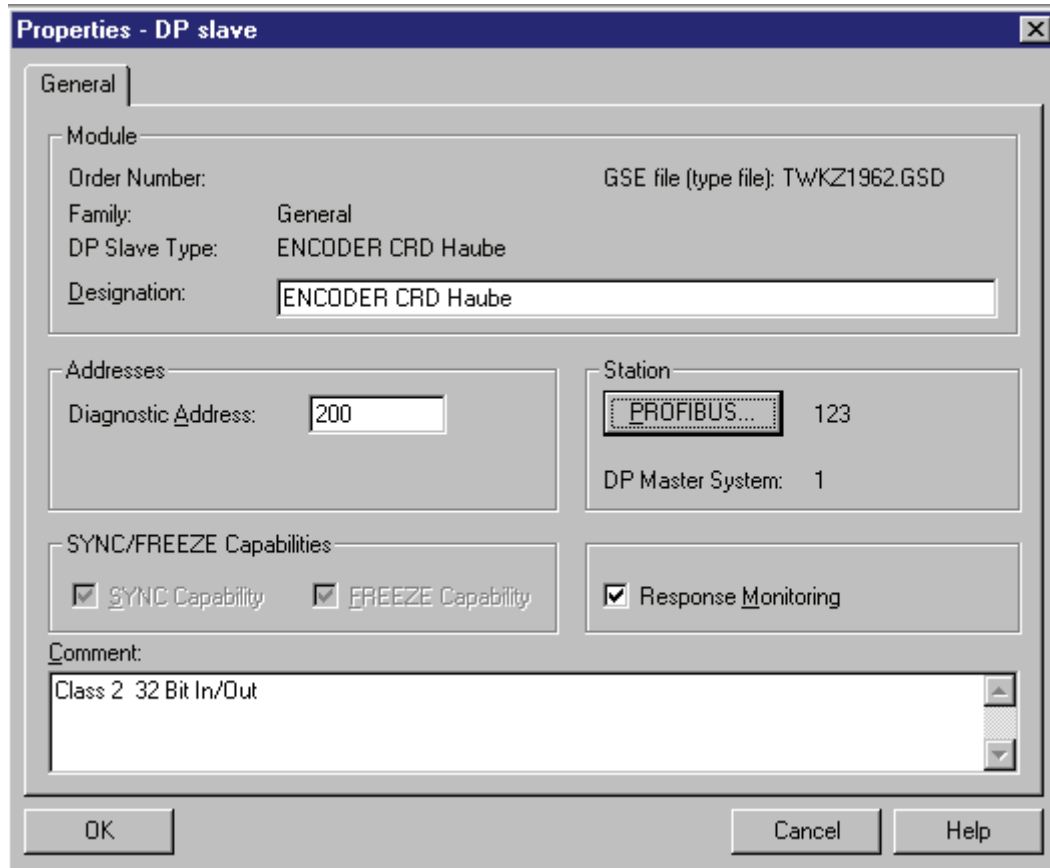

Following confirmation with OK, the encoder is configured and parameterised. The hardware configuration can now be translated and transferred into S7.

8.2 Setting the subscriber address in the case of the plug-version encoder

According to Siemens, the prerequisites for allocating a new address are as follows:

1. No further DP master is contained in the PROFIBUS network.
2. At least one DP slave exists in the PROFIBUS network.
3. A PROFIBUS address has already been directly allocated to each DP slave in the PROFIBUS network (either via software via PG - DP slave direct connection or via setting the switches on the DP slave; Assignment is DP slave-dependent, therefore consult the DP slave manual)
4. You have connected the programming device to the PROFIBUS network via a stub line (See the manual regarding the DP master).

(See on-line help under "Assignment of profibus address" in the Simatic Manager)

Simatic Step7

I.e. if the encoder is not the only slave on the profibus/MPI card, all slaves contained in the bus must possess a unique (allocated only once) address, and the master (S7-CPU) must be disconnected from the bus. It is therefore impossible, for example, to simultaneously connect two encoders with address 123 to the bus and to then assign a new address to one of the two.

If the encoder whose address is to be changed has already previously been used in bus operation, this must be rendered potential-free before it can be set to a new address.

Address setting is carried out in the Simatic Manager under “**PLC , Assign PROFIBUS Address**”. If the encoder is connected to the profibus/MPI interface of your programming device, the depicted dialogue appears.

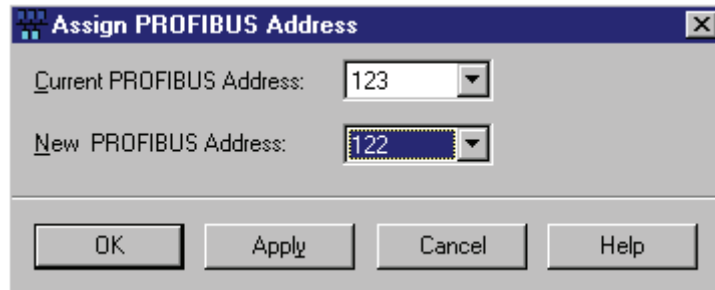

This displays the current address of the encoder, and requests the input of the new profibus address. If this is confirmed with **Apply**, the new address is stored in the encoder in a zero-voltage-protected manner. The dialogue subsequently displays the new address as the current address.

8.3 Example programmes

In the internet several S7 archive files are available, which contain S7 example programmes which have been generated by TWK for working with the TWK profibus encoder. The programmes have been developed for a CPU315-2DP, and have been designed such that no periphery other than a TWK profibus encoder is required. There is one project for encoders with class 1 functionality and one for encoders with class 2 functionality. Each project contains several programme folders for different application cases. The standard "Sources" and "Blocks" folders are located beneath the programme folders.

The TWK examples only contain modules which have been generated with the KOP/FUP/AWL Editor. The generation language was FUP. Within the modules, comprehensive documentation is made available on the basis of network comments.

TWK cannot undertake to provide any guarantee for the function of these programmes on customers' systems/control systems.

Programmes in the archive files:

- TWKDPCL1.ARJ : Class 1 project with Diagnosis and Istwert programme folders, comments in German
- TWKDPCL2.ARJ : Class 2 project with Diagnosis, IstRef and Istwert programme folders, comments in German
- DP_C1_GB.ARJ : Class 1 project with Diagnosis and Istwert programme folders, comments in English
- DP_C2_GB.ARJ : Class 2 Project with Diagnosis, IstRef and Istwert programme folders, comments in English

Because of a modification in the handling of the used system function SFC13 the examples for the diagnosis in the above programmes do not work with actual CPUs. Therefore a new programm example is available (please refer to the additional information in document no. 12532).

- Diag_neu: reading of diagnosis data with SFC13 with german comments
- Diag_new: reading of diagnosis data with SFC13 with english comments

8.3.1 The TWKDPCL1 project

The following Figure shows the class 1 project programme folders:

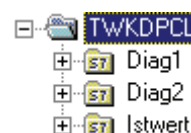

Simatic Step7

Program Istwert: The program Istwert is comprised only of an OB1 and is intended to briefly show the manner in which the actual position value of the encoder is accessed within the S7 programme.

Program Diag1: In addition to the program Istwert, the Diag1 programme also contains error handling for a class 1 encoder. It contains, amongst other things, OB86 for detecting the failure of the encoder, and OB82 for detecting a diagnosis request on the part of the encoder. Step7 system function SFC13 is used to read the diagnosis range out. (The diagnosis range of the class 1 encoder is 16 bytes. See [Chapter 7](#))

Program Diag2: The Diag2 programme provides the same functionality as Diag1, but is designed for two encoders. Within each programme, a selection may be made between functions for a 16 or 32 bit-wide encoder input. To achieve this, either the 16 or the 32 bit function is simply provided with a "1" signal (one-marker M 0.1) at the EN input, and the non-required function with a "0" signal (zero-marker M 0.0).

8.3.2 The TWKDPCL2 project

The class 2 project contains the following programme folders:



Program Istwert: Identical to class 1 programme

Program IstRef: The program IstRef contains the reading out of the actual position value and, in addition, the setting of a preset value, which is possible in the case of class 2 functionality.

Program Diag1: In the same manner as Diag1 from the class 1 project, the Diag1 programme contains the error handling of a class 2 encoder. In this case, the scope of the diagnosis range is 63 bytes.

Program Diag2: Once again, Diag2 is the variant of Diag1 which is extended to encompass two encoders.

8.3.3 Installation of the example programmes

Prerequisites:

- You have generated a project and have inserted a control system into this with its hardware configuration. This may appear as follows, for example:

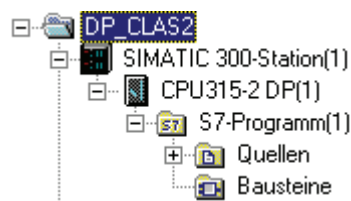

- In the hardware configuration, you have connected one or two encoders with the following settings to a profibus subnetwork:

First encoder: Profibus address 123
 Inputs/outputs: From address 100
 Diagnosis address: 200

Poss.: Second encoder: Profibus address 122
 Inputs/outputs: From address 110
 Diagnosis address: 202

Simatic Step7

Installation:

- In the Simatic Manager, select **File, Retrieve**. Change the file type to *.arj and select the downloaded file
- In the next window, specify your project directory (normally S7proj).
- Via integration with OK, the dearchiving programme is started. After terminating this, you will find your selected TWK example project in your S7 project directory.
- If you now select **File, Open, User project**, you will be provided with a list of the projects available on your system. If the example project is not yet available here, select **Browse** and search for the TWKDPCL1.s7p (or TWKDPCL2.s7p) file under the TWK example project.
- Open the example project so that you now have both projects, your own and the example project, open. This may then, for example, look like the Figure on the next Page.
- Select a subordinate S7 programme folder of the TWK example project. (In this case, either Diag1, Diag2, IstRef or Istwert. Also see: [Chapter 8.3.1](#))

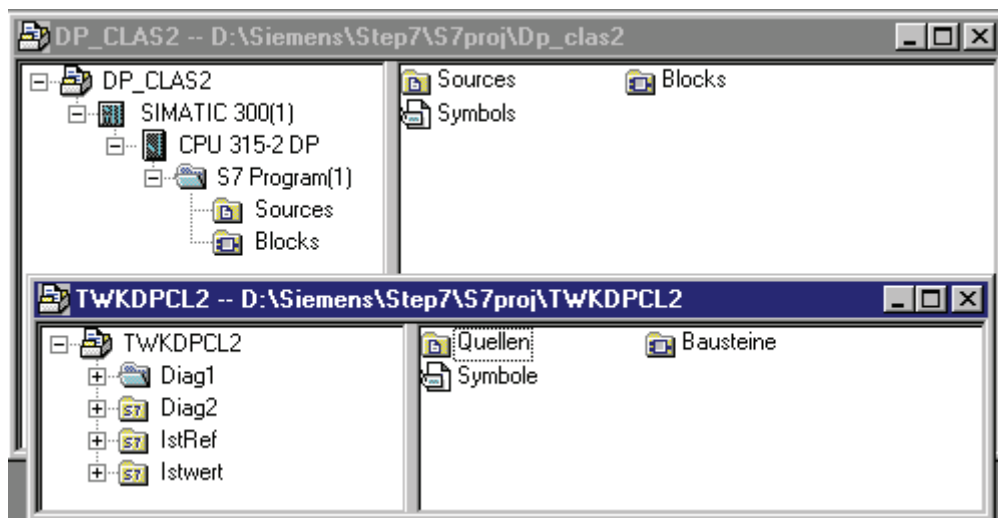

- Copy all of the module container's modules from the selected programme folder (e.g. Diag1 from TWKDPCL2) into your own project's still empty module container (e.g. S7 programme (1) from DP_CLAS2). (Note: Each module container, even an empty one, contains at least one OB1; this is, of course, also empty, and can therefore be overwritten.)
- If you have installed a class 2, 16 bit encoder, and have selected the ActualRef or Diag1/2 programme, you must, in order to set the preset value, release the FB10 in the OB1, i.e. supply the EN input with M 0.1 and block the FB11 (s), i.e. supply the EN input with M 0.0.
- If necessary, replace the M 1.0 – Acknowledge message and the M 10.0 (and M 10.1 in the case of two encoders) – Set the preset value, with your signals.
- Transfer all modules into the control system.
- Now call up the OB1 in the on-line view, and switch Test, Observe on, in order to have the current values of the encoder displayed on the monitor.
- For ActualRef and Diag1/2 programme only: Enter a preset value into DB100 data doubleword 0 (for the second encoder, DB100 data doubleword 8), and set this with the M 10.0 (or M 10.1). If the preset value lies outside of the parameterised measurement range of the encoder, the corresponding error message is set in OB1.

8.3.4 Explanations regarding the example programmes

Each programme folder contains a symbol table, which contains all global variables of the maximum expansion (class 2 project, Diag2 programme).

The programme structure of this maximum expansion is explained in the following. The reference data provide the following overview: (The symbolic name is always contained in the round brackets)

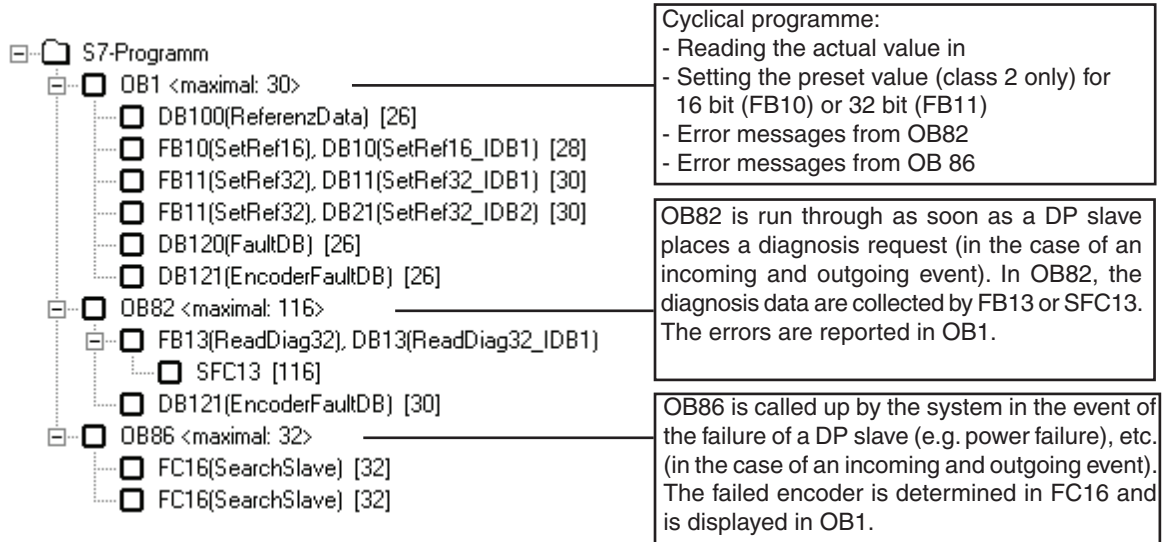

The entire diagnosis range of the disturbed encoder is always read out via system function SFC13 (16 bytes in the case of class 1 and 63 bytes in the case of class 2). The address of this slave is provided by OB82 in its local data.

Only the manufacturer-specific error message bits are evaluated, and of these, only those which may occur in Data Exchange Mode (in normal bus operation). Errors which can occur during bus initialisation cannot be detected by OB82. In this case, the error messages must be read out via the **Diagnosing hardware** function of the Step7 package.

Scope of delivery

9. Scope of delivery

- The scope of delivery includes:
- Encoder with DP interface
 - Pin assignment TY XXXXX (depending on the device variant)

Remark:

The GSD-file, the complete documentation and the example programmes are available for download in the internet www.twk.de under documentation

Literature

10. Literature

- /1/ PROFIBUS Profile for Encoders
Order No. 3.062
1997, PROFIBUS User Organisation Regd. Assoc.
Haid-und-Neu-Str. 7
D-76131 Karlsruhe
- /2/ PROFIBUS
Brief Technical Description
Version: April 1997
PROFIBUS User Organisation
- /3/ DIN 19245 Part 1 PROFIBUS
Process Field Bus Transmission Technology, Bus Access and Transmission Protocol,
Service Interface for Application Layer, Management
- /4/ DIN 19245 Part 3 PROFIBUS
Process Field Bus Decentralised Periphery (DP)
- /5/ SIEMENS SINEC L2
SPC 3 Siemens PROFIBUS Controller
User Description Order No.: 6ES7 195-0BD00-8AA0

Appendix A

Appendix A: Encoder terms

Parameter:	Explanation
Measuring units per revolution:	The single turn resolution specifies the number of measuring units per revolution (360°).
Measuring range:	The measuring range specifies the maximum number of revolutions. Specification of the revolutions must be carried out in 2 ⁿ powers.
Total measuring range in units:	The total measuring range in units is revealed as follows: Total measuring range in units = Single turn resolution x Measuring range
Code sequence:	The code sequence specifies the direction of rotation in which the output code of the encoder corresponds to increasing values. A distinction is made between the following depending on the direction of rotation: CW - clockwise, clockwise direction of rotation CCW - counter clockwise, anti-clockwise direction of rotation (viewed in the direction of the shaft)
Preset value:	The preset value is the value which appears in the encoder's output value parameter according to the preset function.